



## MIC2004/2014

### Fixed Current Limit Power Distribution Switch

## General Description

MIC2004 and MIC2014 are current limiting, high-side power switches, designed for general purpose power distribution and control in PCs, PDAs, printers and other self-powered systems.

MIC2004 and MIC2014's primary functions are current limiting and power switching. They are thermally protected and will shutdown should their internal temperature reach unsafe levels, protecting both the device and the load, under high current or fault conditions. MIC2004/2014 feature a load discharge FET which ensures any output capacitance is discharged when the switch is turned off. This is particularly useful in hot-swapping applications where 'cold' connections are desired.

Both devices are fully self-contained, with the current limit value being factory set to one of several convenient levels.

MIC2014 offers a unique new feature: Kickstart™, which allows momentary high current surges to pass unrestricted without sacrificing overall system safety.

MIC2004 and MIC2014 are excellent choices for USB and IEEE 1394 (FireWire) applications or for any system where current limiting and power control are desired.

The MIC2004 and MIC2014 are offered in space saving 6 pin SOT-23 and 2mm x 2mm MLF packages.

Data sheets and support documentation can be found on Micrel's web site at [www.micrel.com](http://www.micrel.com).

## Features

- 70mΩ typical on-resistance
- 2.5V - 5.5V operating range
- Pre-set current limit values; 0.5A, 0.8A and 1.2A
- Load discharge FET
- Kickstart™
- Thermal Protection
- Under voltage lock-out
- Low quiescent current

## Applications

- USB / IEEE 1394 Power Distribution
- Desktop and Laptop PCs
- Set top boxes
- Game consoles
- PDAs
- Printers
- Docking stations
- Chargers

## Typical Application

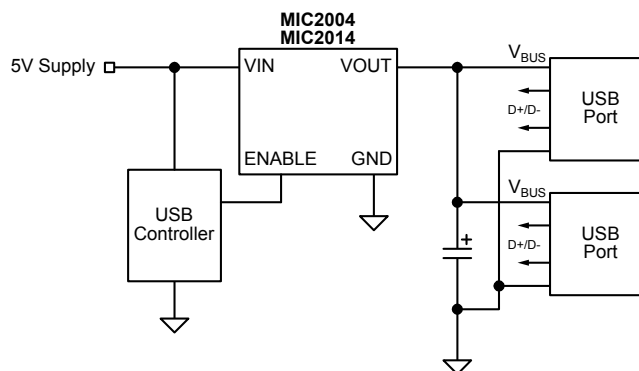

Figure 1. Typical Application Circuit

Kickstart is a trademark of Micrel, Inc  
MLF and MicroLeadFrame are trademarks of Amkor Technology, Inc.

Micrel Inc. • 2180 Fortune Drive • San Jose, CA 95131 • USA • tel +1 (408) 944-0800 • fax + 1 (408) 474-1000 • <http://www.micrel.com>

## MIC2000 Family Members

Part Number		I Limit	Pin Function					Load Discharge
Normal Limiting	Kickstart		I Adj.	Enable	C <sub>SLEW</sub>	FAULT/	DLM*	
2003	2013	Fixed	--	--	--	--	--	--
2004	2014		--	▲	--	--	--	▲
2005	2015		--	▲	▲	▲	--	--
2006	2016		--	▲	▲	--	▲	--
2007	2017	Adj.	▲	▲	▲	--	--	▲
2008	2018		▲	▲	▲	--	--	--
2009	2019		▲	▲	--	▲	--	--

\* Dynamic Load Management    Adj = Adjustable current limit    Fixed = Factory programmed current limit

## Ordering Information

Part Number	Marking <sup>(1)</sup>	Current Limit	Kickstart	Pb-Free	Package
MIC2004-0.5YM5	<u>FE</u> 05	0.5A	No	Yes	SOT-23-5
MIC2004-0.8YM5	<u>FE</u> 08	0.8A			
MIC2004-1.2YM5	<u>FE</u> 12	1.2A			
MIC2004-0.5YML <sup>(2)</sup>	<u>E</u> 05	0.5A			2mmX2mm MLF
MIC2004-0.8YML <sup>(2)</sup>	<u>E</u> 08	0.8A			
MIC2004-1.2YML <sup>(2)</sup>	<u>E</u> 12	1.2A			
MIC2014-0.5YM5	<u>FM</u> 05	0.5A	Yes	Yes	SOT-23-5
MIC2014-0.8YM5	<u>FM</u> 08	0.8A			
MIC2014-1.2YM5	<u>FM</u> 12	1.2A			
MIC2014-0.5YML <sup>(2)</sup>	<u>M</u> 05	0.5A			2mmX2mm MLF
MIC2014-0.8YML <sup>(2)</sup>	<u>M</u> 09	0.8A			
MIC2014-1.2YML <sup>(2)</sup>	<u>M</u> 12	1.2A			

### Note:

1. Under-bar symbol (    ) may not be to scale
2. Contact factory for availability.

### Pin Configuration

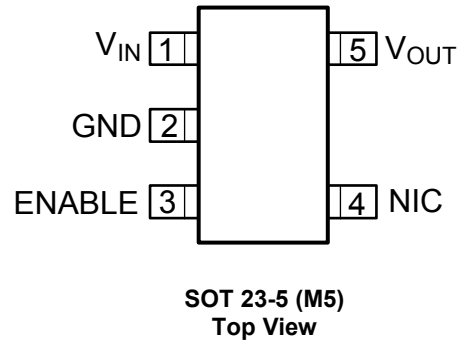
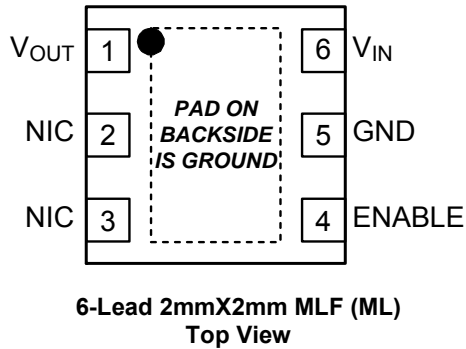

### Pin Description

Pin Number SOT-23	Pin Number MLF	Pin Name	Type	Description
1	6	VIN	Input	Supply input. This pin provides power to both the output switch and the MIC2004/2014's internal control circuitry.
2	5	GND	--	Ground.
3	4	ENABLE	Input	Output enable pin. A logic HIGH activates the output switch, applying power to the load attached to V <sub>OUT</sub> .
4	3	NIC	--	No internal connection. An electrical signal to this pin will have no effect on device operation.
	2	NIC	--	No internal connection. An electrical signal to this pin will have no effect on device operation.
5	1	VOUT	Output	Switch output. The load being driven by MIC2004/2014 is connected to this pin.

### Absolute Maximum Ratings<sup>(1)</sup>

V<sub>IN</sub>, V<sub>OUT</sub>.....-0.3 to 6V  
 All other pins.....-0.3 to 5.5V  
 Power Dissipation..... Internally Limited  
 Continuous Output Current..... 2.25A  
 Maximum Junction Temperature..... 150°C  
 Storage Temperature..... -65°C to 150°C

### Operating Ratings<sup>(2)</sup>

Supply Voltage..... 2.5V to 5.5V  
 Continuous Output Current Range ..... 0 to 2.1A  
 Ambient Temperature Range .....-40°C to 85°C  
 Package Thermal Resistance (θ<sub>JA</sub>)  
 SOT-23-5 ..... 230°C/W  
 MLF 2x2 mm..... 90°C/W  
 MLF 2x2 mm θ<sub>JC</sub><sup>(5)</sup> ..... 45°C/W

### Electrical Characteristics

V<sub>IN</sub> = 5V, T<sub>AMBIENT</sub> = 25°C unless specified otherwise. **Bold** indicates -40°C to +85°C limits.

Symbol	Parameter	Conditions	Min	Typ	Max	Units
V <sub>IN</sub>	Switch Input Voltage		<b>2.5</b>		<b>5.5</b>	V
I <sub>IN</sub>	Internal Supply Current	Switch = OFF, ENABLE = 0V		1	<b>5</b>	μA
I <sub>IN</sub>	Internal Supply Current	Switch = ON, I <sub>OUT</sub> = 0 ENABLE = 1.5V		80	<b>330</b>	μA
I <sub>LEAK</sub>	Output Leakage Current	V <sub>IN</sub> = 5V, V <sub>OUT</sub> = 0 V, ENABLE = 0		12	<b>100</b>	μA
R <sub>DS(ON)</sub>	Power Switch Resistance	V <sub>IN</sub> = 5V, I <sub>OUT</sub> = 100 mA		70	100	mΩ
					<b>125</b>	mΩ
R <sub>DSCHG</sub>	Load Discharge Resistance	V <sub>IN</sub> = 5V, I <sub>SINK</sub> = 5 mA	<b>70</b>	126	<b>200</b>	Ω
I <sub>LIMIT</sub>	Current Limit: -0.5	V <sub>OUT</sub> = 0.8V <sub>IN</sub>	0.5	0.7	0.9	A
I <sub>LIMIT</sub>	Current Limit: -0.8	V <sub>OUT</sub> = 0.8V <sub>IN</sub>	0.8	1.1	1.5	A
I <sub>LIMIT</sub>	Current Limit: -1.2	V <sub>OUT</sub> = 0.8V <sub>IN</sub>	1.2	1.6	2.1	A
I <sub>LIMIT_2nd</sub>	Secondary current limit (Kickstart)	MIC2014, V <sub>IN</sub> = 2.5V	2.2	4	6	A
UVLO <sub>THRESHOLD</sub>	Under Voltage Lock Out threshold	V <sub>IN</sub> rising	<b>2.0</b>	2.25	<b>2.5</b>	V
		V <sub>IN</sub> falling	<b>1.9</b>	2.15	<b>2.4</b>	V
V <sub>EN</sub>	ENABLE Input Voltage	V <sub>IL</sub> (max.)			<b>0.5</b>	V
		V <sub>IH</sub> (min.)	<b>1.5</b>			
I <sub>EN</sub>	ENABLE Input Current	V <sub>EN</sub> = 0V to 5.0V		1	<b>5</b>	μA
OT <sub>THRESHOLD</sub>	Over-temperature Threshold	T <sub>J</sub> increasing		145		°C
		T <sub>J</sub> decreasing		135		

## AC Characteristics

Symbol	Parameter	Condition	Min	Typ	Max	Units
$t_{RISE}$	Output turn-ON rise time	$R_L = 10\Omega$ , $C_{LOAD} = 1\mu F$ , $V_{OUT} = 10\%$ to $90\%$	500	1000	1500	$\mu s$
$t_{D\_LIMIT}$	Delay before current limiting	MIC2014	<b>77</b>	128	<b>192</b>	ms
$t_{RESET}$	Delay before resetting Kickstart current limit delay, $t_{D\_LIMIT}$	Out of current limit following a current limit event. MIC2014	<b>77</b>	128	<b>192</b>	ms
$t_{ON\_DLY}$	Output Turn-on Delay	$R_L = 43\Omega$ , $C_L = 120\mu F$ , $C_{SLEW} \leq 10pF$ , $V_{EN} = 50\%$ to $V_{OUT} = 10\%$		1000	1500	$\mu s$
$t_{OFF\_DLY}$	Output Turn-off Delay	$R_L = 43\Omega$ , $C_L = 120\mu F$ , $C_{SLEW} \leq 10pF$ , $V_{EN} = 50\%$ to $V_{OUT} = 90\%$			700	$\mu s$

## ESD

Symbol	Parameter	Condition	Min	Typ	Max	Units
$V_{ESD\_HB}$	Electro Static Discharge Voltage: Human Body Model	$V_{OUT}$ and GND	$\pm 4$			kV
		All other pins	$\pm 2$			kV
$V_{ESD\_MCHN}$	Electro Static Discharge Voltage; Machine Model	All pins Machine Model	$\pm 200$			V

### Notes:

1. Exceeding the absolute maximum rating may damage the device.
2. The device is not guaranteed to function outside its operating rating.
3. Devices are ESD sensitive. Handling precautions recommended. Human body model, 1.5k in series with 100pF.
4. Specification for packaged product only.
5. Requires proper thermal mounting to achieve this performance.

# Timing Diagrams

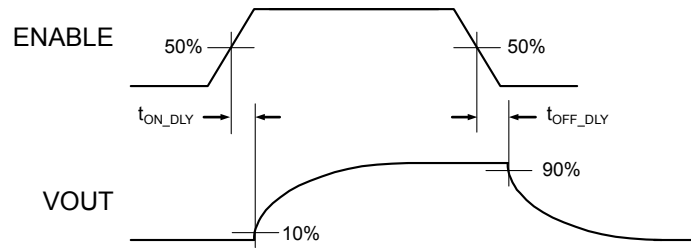

**Switching Delay Times**

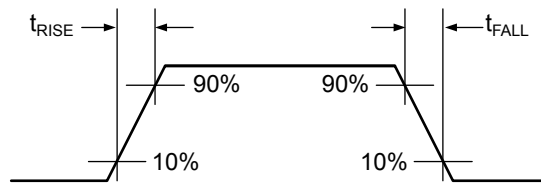

**Rise and Fall Times**

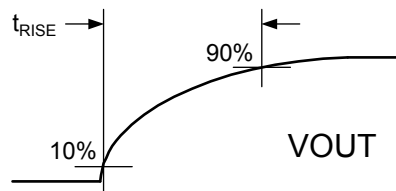

**Output Rise Time**

# Typical Characteristics

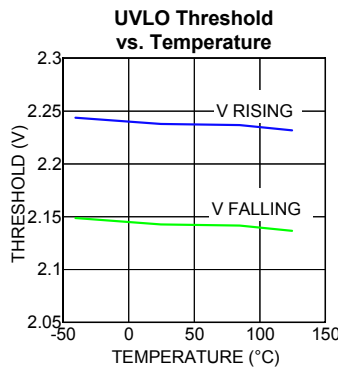
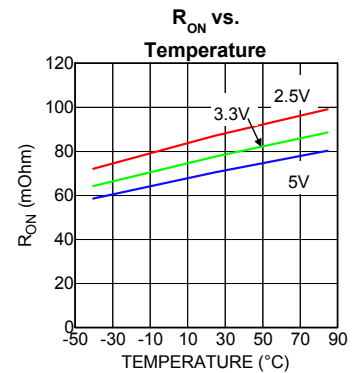
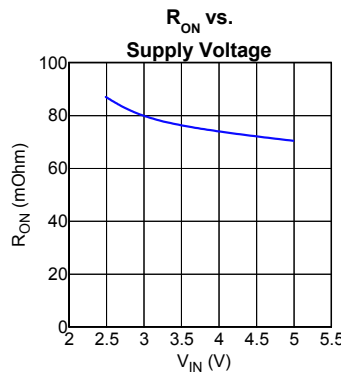
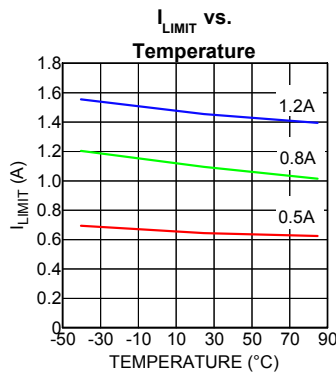
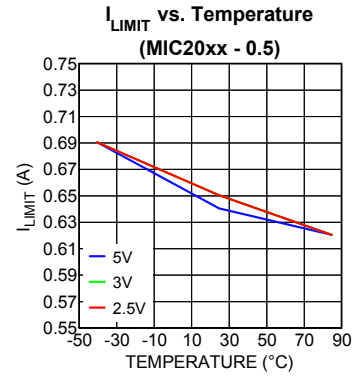
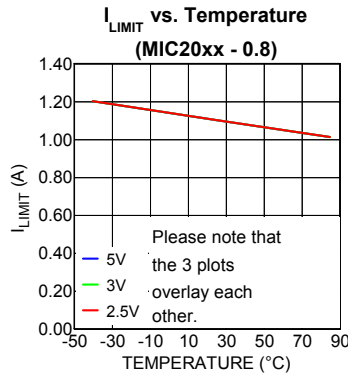
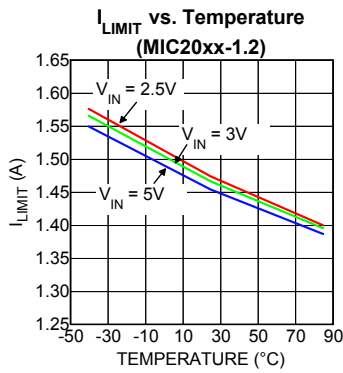
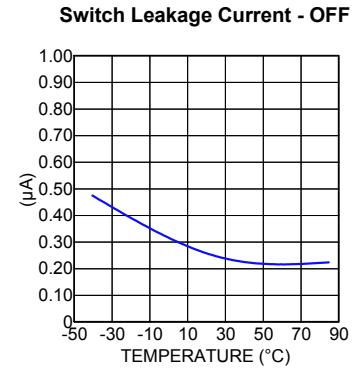
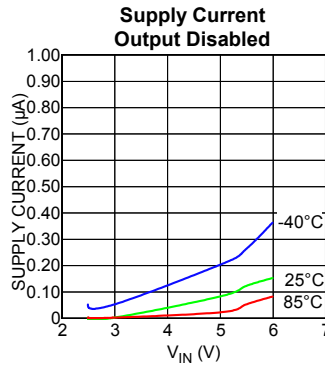
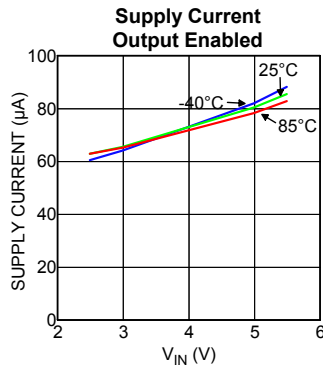

# Functional Characteristics

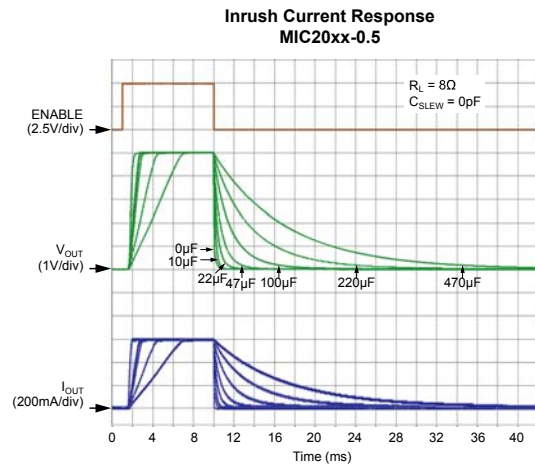
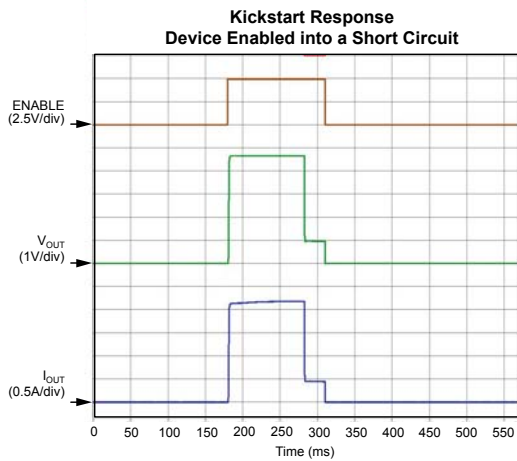
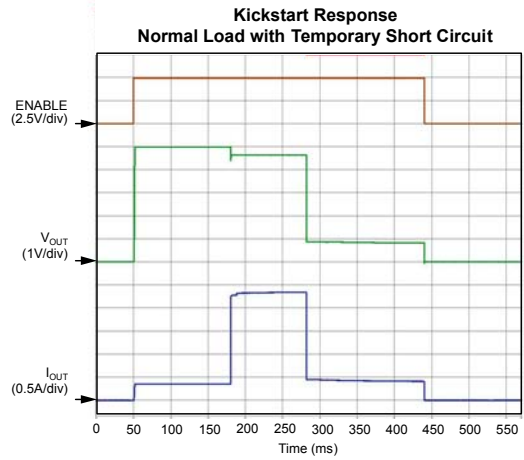
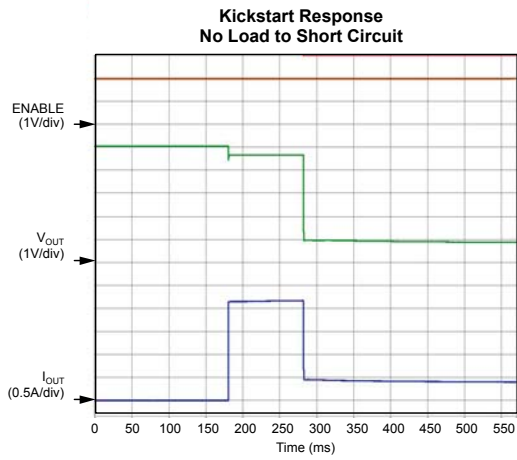
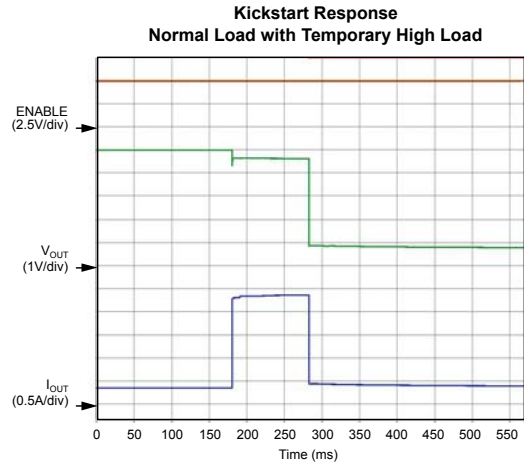
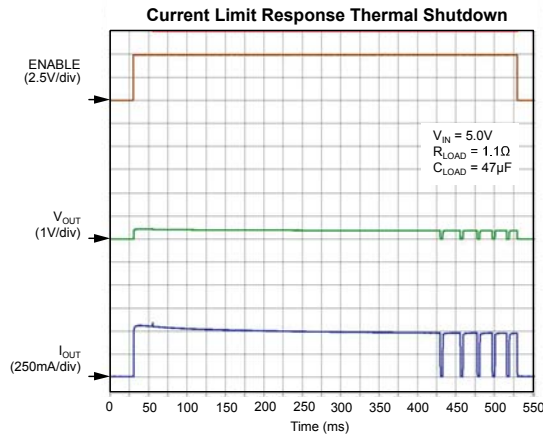



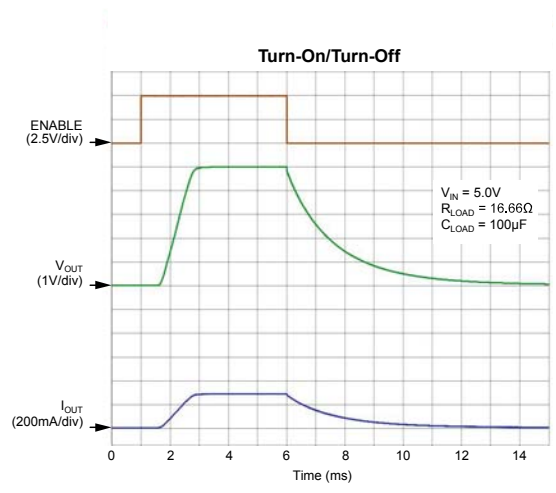
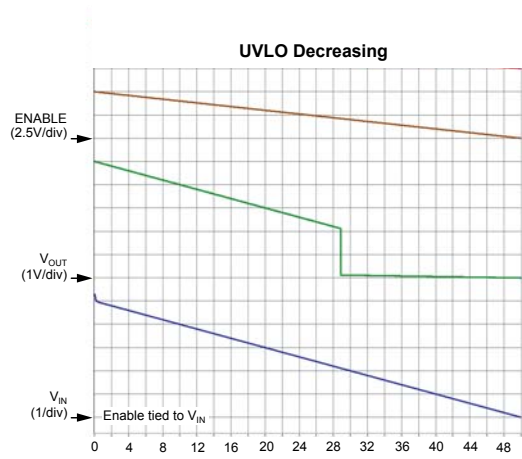
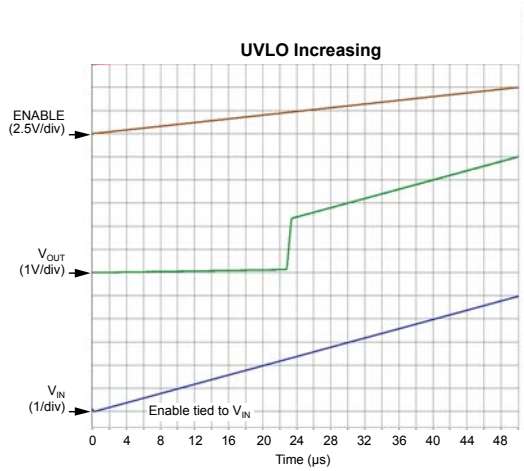

### Functional Diagram

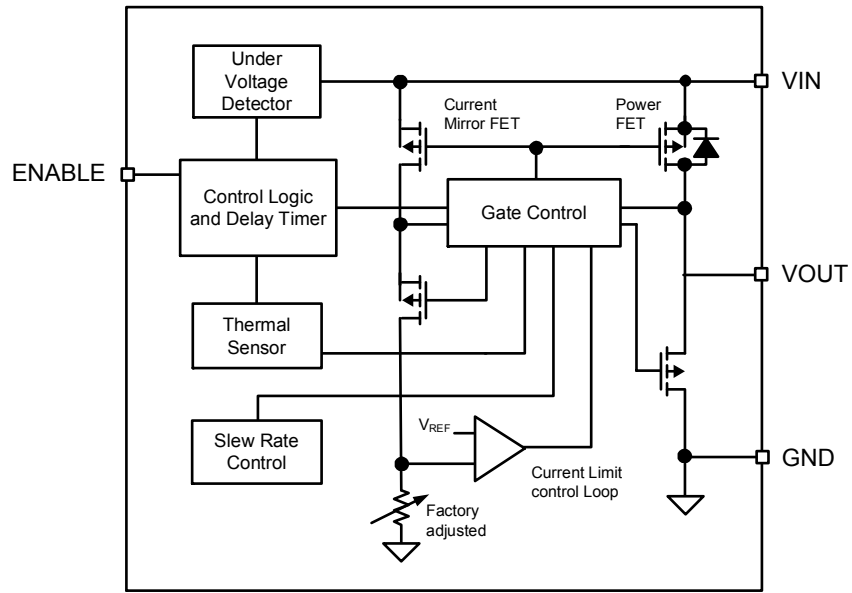

Figure 2 MIC2004/2014 Block Diagram

## Functional Description

### Input and Output

$V_{IN}$  is both the power supply connection for the internal circuitry driving the switch and the input (Source connection) of the power MOSFET switch.  $V_{OUT}$  is the Drain connection of the power MOSFET and supplies power to the load. In a typical circuit, current flows from  $V_{IN}$  to  $V_{OUT}$  toward the load. Since the switch is bi-directional when enabled, if  $V_{OUT}$  is greater than  $V_{IN}$ , current will flow from  $V_{OUT}$  to  $V_{IN}$ .

When the switch is disabled, current will not flow to the load, except for a small unavoidable leakage current of a few microamps. However, should  $V_{OUT}$  exceed  $V_{IN}$  by more than a diode drop ( $\sim 0.6V$ ), while the switch is disabled, current will flow from output to input via the power MOSFET's body diode. While this effect can be used to advantage when large bypass capacitors are placed on MIC2004/2014's output, it can not be relied upon to fully or reliably discharge the load capacitance, because discharging depends upon the characteristics of the circuitry at  $V_{IN}$ .

To ensure proper discharge of any output capacitance, MIC2004/2014 is equipped with a discharge FET which is ON any time the device is not Enabled.

### Current Sensing and Limiting

MIC2004/2014 protects the system power supply and load from damage by continuously monitoring current through the on-chip power MOSFET. Load current is monitored by means of a current mirror in parallel with the power MOSFET switch. Current limiting is invoked when the load exceeds an internally set over-current threshold. When current limiting is activated the output current is constrained to the limit value, and remains at this level until either the load/fault is removed, the load's current requirement drops below the limiting value, or the MIC2004/2014 goes into thermal shutdown.

### Kickstart (MIC2014 only)

The MIC2014 is designed to allow momentary current surges (Kickstart) before the onset of current limiting, which permits dynamic loads, such as small disk drives or portable printers to draw the energy needed to overcome inertial loads without sacrificing system safety. In this respect, the MIC2014 differs markedly from MIC2004 and its peers, which immediately limit load current, potentially starving the motor and causing the appliance to stall or stutter.

During this delay period, typically 128 ms, a secondary current limit is in effect. If the load demands a current in excess the secondary limit, MIC2014 acts immediately to restrict output current to the secondary limit for the duration of the Kickstart period. After this time the

MIC2014 reverts to its normal current limit. An example of Kickstart operation is shown below.

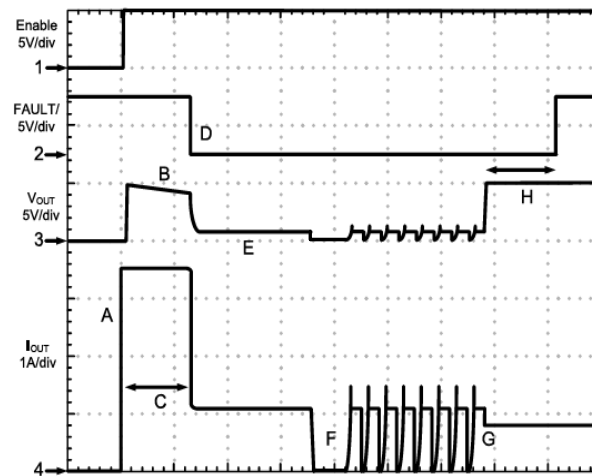

Figure 3. Kickstart Operation

#### Picture Key:

- A) MIC2014 is enabled into an excessive load (slew rate limiting not visible at this time scale) The initial current surge is limited by either the overall circuit resistance and power supply compliance, or the secondary current limit, whichever is less.
- B)  $R_{ON}$  of the power FET increases due to internal heating (effect exaggerated for emphasis).
- C) Kickstart period.
- D) Current limiting initiated. FAULT/ goes LOW (Note: FAULT/ output is not available on MIC2014).
- E)  $V_{OUT}$  is non-zero (load is heavy, but not a dead short where  $V_{OUT} = 0$ ). Limiting response will be the same for dead shorts).
- F) Thermal shutdown followed by thermal cycling.
- G) Excessive load released, normal load remains. MIC2014 drops out of current limiting.
- H) FAULT/ delay period followed by FAULT/ going HIGH. (FAULT/ output is not available on MIC2014).

### Under Voltage Lock Out

Under voltage lock-out insures no anomalous operation occurs before the device's minimum input voltage of 2.5V had been achieved. Prior to reaching this voltage, the output switch (power MOSFET) is OFF and no circuit functions, such as FAULT/ or ENABLE, are considered to be valid or operative.

### Enable

ENABLE is a HIGH true control signal, which activates

the main MOSFET switch. ENABLE will operate with logic running from supply voltages as low as 1.8V. ENABLE can be wire-OR'd with other MIC2004/2014s or similar devices without damage to the device.

ENABLE may be driven higher than  $V_{IN}$ , but no higher than 5.5V.

#### **Slew Rate Control**

Large capacitive loads can create significant current surges when charged through a high-side switch such as the MIC2004/2014. For this reason, MIC2004/2014 provides built-in slew rate control to limit the initial inrush currents upon enabling the power MOSFET switch.

Slew rate control is active upon powering up, and upon re-enabling the load. At shutdown, the discharge slew rate is controlled by the external load and output capacitor.

#### **Thermal Shutdown**

Thermal shutdown is employed to protect

MIC2004/2014 from damage should the die temperature exceed safe operating levels. Thermal shutdown shuts off the output MOSFET if the die temperature reaches 145°C.

MIC2004/2014 will automatically resume operation when the die temperature cools down to 135°C. If resumed operation results in reheating of the die, another shutdown cycle will occur and the MIC2004/2014 will continue cycling between ON and OFF states until the offending load has been removed.

Depending on PCB layout, package type, ambient temperature, etc., hundreds of milliseconds may elapse from the incidence of a fault to the output MOSFET being shut off. This delay is due to thermal time constants within the system itself. In no event will the device be damaged due to thermal overload because die temperature is monitored continuously by on-chip circuitry.

## Application Information

### $I_{LIMIT}$ vs. $I_{OUT}$ measured

MIC2004/2014's current limiting circuitry is designed to act as a constant current source to the load. As the load tries to pull more than the allotted current,  $V_{OUT}$  drops and the input to output voltage differential increases. When  $V_{IN} - V_{OUT}$  exceeds 1V,  $I_{OUT}$  drops below  $I_{LIMIT}$  to reduce the drain of fault current on the system's power supply and to limit internal heating of MIC2004/2014.

When measuring  $I_{OUT}$  it is important to bear this voltage dependence in mind, otherwise the measurement data may appear to indicate a problem when none really exists. This voltage dependence is illustrated in Figures 4 and 5.

In Figure 4 output current is measured as  $V_{OUT}$  is pulled below  $V_{IN}$ , with the test terminating when  $V_{OUT}$  is 1V below  $V_{IN}$ . Observe that once  $I_{LIMIT}$  is reached  $I_{OUT}$  remains constant throughout the remainder of the test. In Figure 5 this test is repeated but with  $V_{IN} - V_{OUT}$  exceeding 1V.

When  $V_{IN} - V_{OUT} > 1V$ , MIC2004/2014's current limiting circuitry responds by decreasing  $I_{OUT}$ , as can be seen in Figure 5. In this demonstration,  $V_{OUT}$  is being controlled and  $I_{OUT}$  is the measured quantity. In real life applications  $V_{OUT}$  is determined in accordance with Ohm's law by the load and the limiting current.

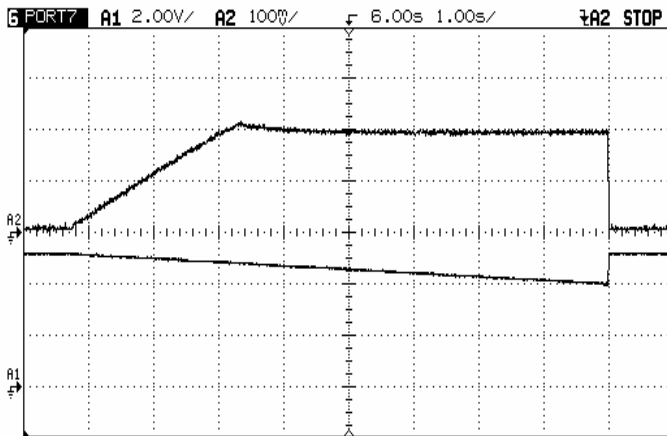

2009B SOT 502 #1 - Vout ramp 5V to 4V (5V)  
 Radj=249ohms, Rfault=499ohms  
 A1: Vout (2V/div)  
 A2: Iout (500mA/div)

**Figure 4.**  $I_{OUT}$  in Current Limiting for  $V_{IN} - V_{OUT} \leq 1V$

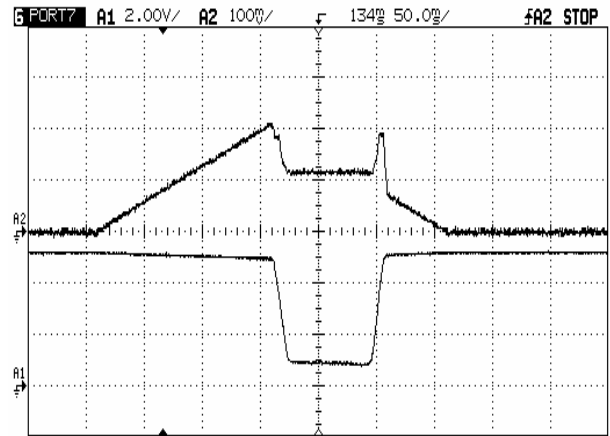

2009B SOT 502 #1 - Current ramp (5V)  
 Radj=249ohms, Rfault=499ohms  
 A1: Vout (2V/div)  
 A2: Iout (500mA/div)

**Figure 5.**  $I_{OUT}$  in Current Limiting for  $V_{IN} - V_{OUT} > 1V$

This folding back of  $I_{LIMIT}$  can be generalized by plotting  $I_{LIMIT}$  as a function of  $V_{OUT}$ , as shown below. The slope of  $V_{OUT}$  between  $I_{OUT} = 0$  and  $I_{OUT} = I_{LIMIT}$  (where  $I_{LIMIT} = 1$ ) is determined by  $R_{ON}$  of MIC2004/2014 and  $I_{LIMIT}$ .

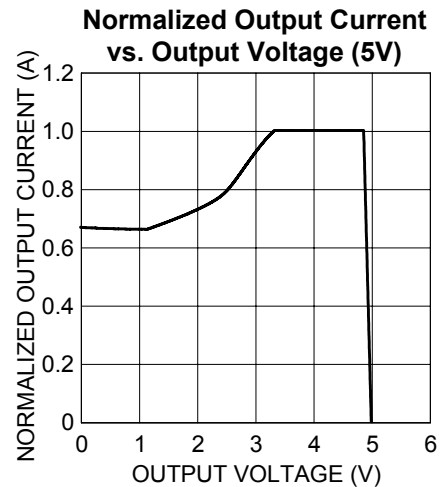

**Figure 6.**

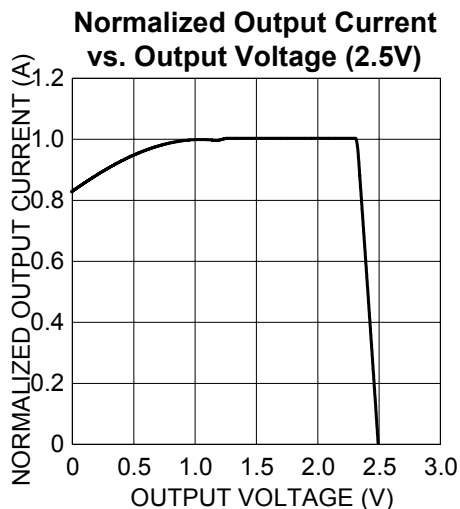

Figure 7.

**Kickstart (MIC2014)**

Kickstart allows brief current surges to pass to the load before the onset of normal current limiting, which permits dynamic loads to draw bursts of energy without sacrificing system safety.

Functionally, Kickstart is a forced override of the normal current limiting function provided by MIC2014. The Kickstart period is governed by an internal timer which allows current to pass unimpeded to the load for 128ms and then normal (primary) current limiting goes into action.

During Kickstart a secondary current limiting circuit is monitoring output current to prevent damage to the MIC2014, as a hard short combined with a robust power supply can result in currents of many tens of amperes. This secondary current limit is nominally set at 4 Amps and reacts immediately and independently of the Kickstart period. Once the Kickstart timer has finished its count the primary current limiting circuit takes over and holds  $I_{OUT}$  to its programmed limit for as long as the excessive load persists.

Once MIC2014 drops out of current limiting the Kickstart timer initiates a lock-out period of 128ms such that no further bursts of current above the primary current limit, will be allowed until the lock-out period has expired.

Kickstart may be over-riden by the thermal protection circuit and if sufficient internal heating occurs, Kickstart will be terminated and  $I_{OUT} \rightarrow 0$ . Upon cooling, if the load is still present  $I_{OUT} \rightarrow I_{LIMIT}$ , not  $I_{KICKSTART}$ .

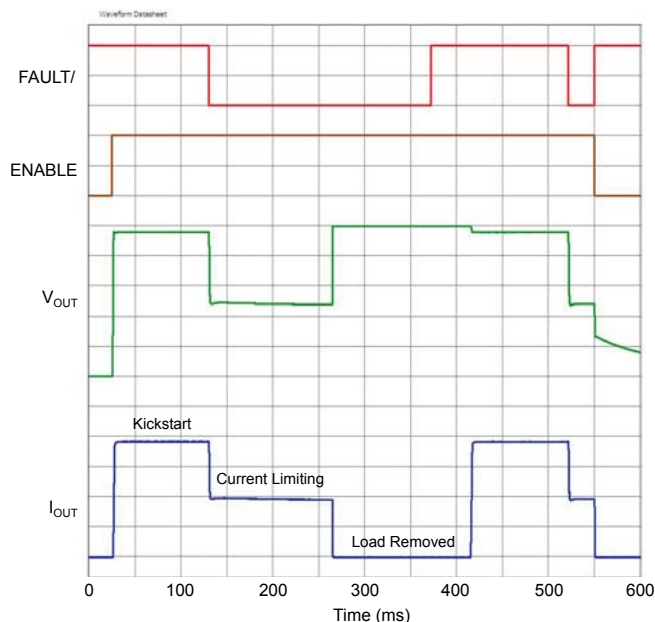

Figure 9. Kickstart

**Supply Filtering**

A 0.1µF to 1µF bypass capacitor positioned close to the  $V_{IN}$  and GND pins of MIC2004/2014 is both good design practice and required for proper operation of MIC2004/2014. This will control supply transients and ringing. Without a bypass capacitor, large current surges or an output short may cause sufficient ringing on  $V_{IN}$  (from supply lead inductance) to cause erratic operation of MIC2004/2014's control circuitry. Good quality, low ESR capacitors, such as Panasonic's TE or ECJ series, are suggested.

When bypassing with capacitors of 10µF and up, it is good practice to place a smaller value capacitor in parallel with the larger to handle the high frequency components of any line transients. Values in the range of 0.01µF to 0.1µF are recommended. Again, good quality, low ESR capacitors should be chosen.

**Power Dissipation**

Power dissipation depends on several factors such as the load, PCB layout, ambient temperature, and supply voltage. Calculation of power dissipation can be accomplished by the following equation:

$$P_D = R_{DS(ON)} \times (I_{OUT})^2$$

To relate this to junction temperature, the following equation can be used:

$$T_J = P_D \times R_{\theta(J-A)} + T_A$$

Where:  $T_J$  = junction temperature,

$T_A$  = ambient temperature

$R_{\theta(J-A)}$  is the thermal resistance of the package

In normal operation MIC2004/2014's  $R_{on}$  is low enough that no significant  $I^2R$  heating occurs. Device heating is most often caused by a short circuit, or very heavy load, when a significant portion of the input supply voltage appears across MIC2004/2014's power MOSFET. Under these conditions the heat generated will exceed the package and PCB's ability to cool the device and thermal limiting will be invoked.

In Figure 10 die temperature is plotted against  $I_{OUT}$  assuming a constant case temperature of 85°C. The plots also assume a worst case  $R_{ON}$  of 140 mΩ at a die temperature of 135°C. Under these conditions it is clear that an SOT-23 packaged device will be on the verge of thermal shutdown, typically 145°C die temperature, when operating at a load current of 1.25A. For this reason we recommend using MLF packaged MIC2004/2014s for any design intending to supply continuous currents of 1A or more.

**Figure 10. Die Temperature vs.  $I_{OUT}$**

Figure 10 assumes no backside contact is made to the thermal pad provided on the MLF package. For optimal performance at higher current levels, or in higher temperature environments, thermal contact with the PCB and the exposed power paddle on the back side of the MLF package should be made. This significantly reduces the package's thermal resistance and thus extends the MIC2004/2014's operating range. It should be noted that this backside paddle is electrically active and is connected to MIC2004/2014's GND pin.

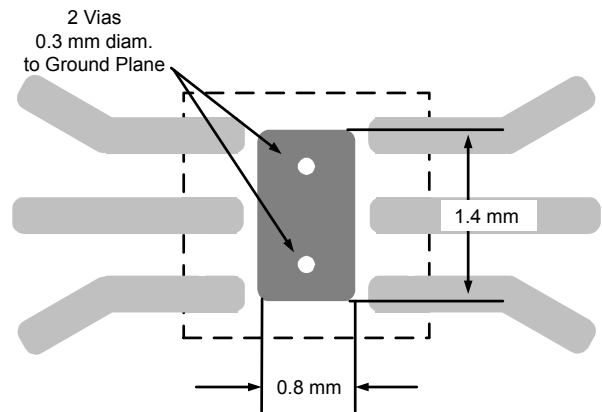
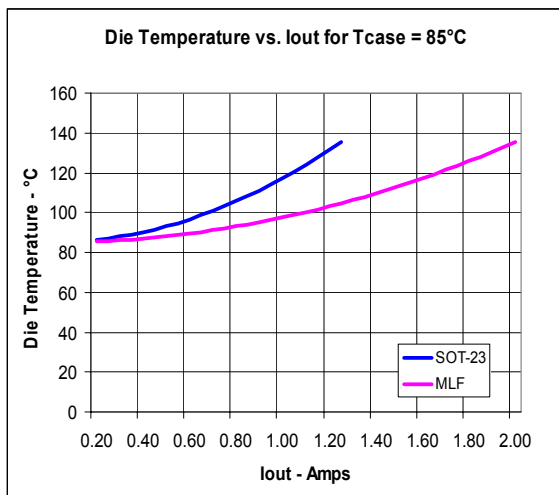

**Figure 11. Pad for thermal mounting to PCB**

**Package Information**

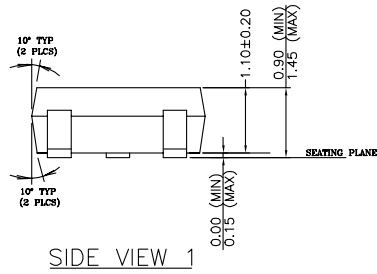
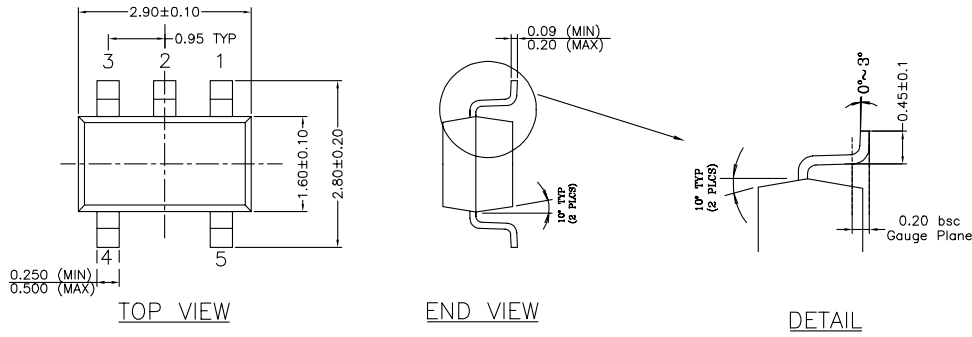

- NOTE:  
 1. PACKAGE OUTLINE EXCLUSIVE OF MOLD FLASH & BURR.  
 2. PACKAGE OUTLINE INCLUSIVE OF SOLER PLATING.  
 3. DIMENSION AND TOLERANCE PER ANSI Y14.5M, 1982.  
 4. FOOT LENGTH MEASUREMENT BASED ON GAUGE PLANE METHOD.  
 5. DIE FACES UP FOR MOLD, AND FACES DOWN FOR TRIM/FORM.

**5-Pin SOT-23 (M5)**

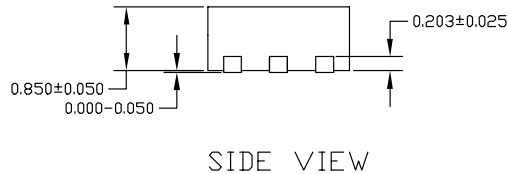
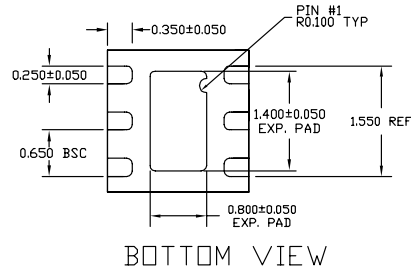
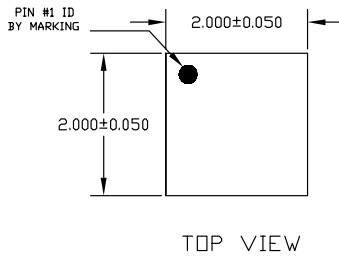

- NOTE:  
 1. ALL DIMENSIONS ARE IN MILLIMETERS.  
 2. MAX. PACKAGE WARPAGE IS 0.05 mm.  
 3. MAXIMUM ALLOWABLE BURRS IS 0.076 mm IN ALL DIRECTIONS.  
 4. PIN #1 ID ON TOP WILL BE LASER MARKED.

**6 Pin 2mmX2mm MLF (ML)**

**MICREL, INC. 2180 FORTUNE DRIVE SAN JOSE, CA 95131 USA**  
 TEL +1 (408) 944-0800 FAX +1 (408) 474-1000 WEB <http://www.micrel.com>

The information furnished by Micrel in this data sheet is believed to be accurate and reliable. However, no responsibility is assumed by Micrel for its use. Micrel reserves the right to change circuitry and specifications at any time without notification to the customer.

Micrel Products are not designed or authorized for use as components in life support appliances, devices or systems where malfunction of a product can reasonably be expected to result in personal injury. Life support devices or systems are devices or systems that (a) are intended for surgical implant into the body or (b) support or sustain life, and whose failure to perform can be reasonably expected to result in a significant injury to the user. A Purchaser's use or sale of Micrel Products for use in life support appliances, devices or systems is a Purchaser's own risk and Purchaser agrees to fully indemnify Micrel for any damages resulting from such use or sale.